



**INSTRUCTION MANUAL
FOR OVER/UNDER**

**READ THE INSTRUCTIONS AND
WARNINGS IN THIS MANUAL CAREFULLY
BEFORE USING THIS FIREARM**

GUN SAFETY RULES

Observe these rules of safe gun handling.

1. Always keep the muzzle pointed in a safe direction. Watch the muzzle at all time: never point a gun, accidentally or intentionally, at any person or anything you do not intend to shoot. Identify the target before shooting; do not shoot at sounds.
2. Always treat a gun as if it is loaded – it may be!
3. Keep your finger off the trigger while operating the action and at all other times until you are ready to shoot.
4. Keep the safety “on” or in the “safe” position at all times until you are ready to fire. Do not rely on your gun’s safety, the safety on any gun is a mechanical device and is not intended as a substitute for common sense or safe gun handling.
5. Learn how your gun functions and handles. If you do not thoroughly understand the proper use and care of your gun, seek the advice of someone who is knowledgeable.
6. Do not alter or modify any part of the firearm.
7. Store guns unloaded, separate from any ammunition, and out of the reach of children.
8. Be sure the barrels is clear of any obstructions before loading. Make it a habit to check the barrel every time before loading.
9. Be sure you have and use the proper ammunition. A 20 gauge shell will enter a 12gauge chamber far enough so that a 12 gauge shell can be loaded behind it. Also, a 3 inch shell may fit into a 2 $\frac{3}{4}$ inch chamber, but the crimp at the mouth of the shell will unfold into the forcing cone. If either of these things occur and you fire the gun, the gun will explode, damaging the gun and possibly causing serious injury or death to you and those around you.
10. Wear protective shooting glasses and adequate ear protection when shooting.
11. Never climb or jump over anything, such as a tree, fence, or ditch, with a loaded gun. Open the barrel, remove the shells and hand the gun to someone else or place it on the ground on the other side of the obstacle before crossing it yourself. Do not lean a gun against a tree or other object; it could fall and possibly discharge.
12. Do not shoot at a hard surface or at water. Bullet and shot can ricochet or bounce off and travel in unpredictable directions with great velocity.
13. Never transport a loaded gun. DO not place a loaded gun into a vehicle. The gun should be unloaded and placed into a case when not in use.
14. Never drink alcoholic beverages before or during shooting.

INTRODUCTION TO TRISTAR SPORTING ARMS

For many years, TriStar has been importing quality shotguns. Combine the old world quality with modern technology, and you have TriStar Shotguns.

We at TriStar thank you for the privilege of delivering a product to you that will provide you with years of pleasurable use. Happy shot gunning.

ABOUT YOUR OVER & UNDER SHOTGUN

Two firing mechanisms are available in these double barrel shotguns. Boxlocks house the firing mechanism behind a false breech and are enclosed in a metal frame.

To remove or unload shot shells, our shotguns have extractors and ejectors. The extractor model elevates the head of a live (or spent) shell from the chamber so it can be removed manually. Ejectors do what you would imagine; they eject the fired shell from the barrel. Our ejectors are automatic selective ejectors which mean they eject only fired shot shells.

Triggers come in three types; double, single, and single selective. Double triggers have one barrel assigned to each trigger. The single trigger fires the barrels in a set order. The single selective trigger works like the single trigger, except it has a button that allows you to select which barrel fires first. TriStar Over & Under shotguns come with single selective triggers. The selection is located on the safety. Push the safety (while in the safe position) to the left side to fire the top barrel first and to the right to fire the bottom barrel first.

SAFETY BUTTON

- A. The safety switch (button) is located on the top tang of your firearm.
- B. To engage the safety, slide the button rearward so the letter "S" is visible.
The safety should always be in the "on" or "safe" position until the time you intend to fire.
- C. When you are ready to fire the shotgun, slide the safety button forward to the "off safe" position so that the letter "S" is not visible.



WARNING: Do not rely solely on your gun's safety. Treat every gun as if it is loaded and ready to fire. The safety is a mechanical device and is not intended to serve as a substitute for common sense or safe gun handling. Always keep the muzzle pointed in a safe direction.

DANGER: The shotgun will fire when the trigger is pulled when the safety button is in the forward or "off" position and the "S" does not show. Always keep the muzzle pointed in a safe direction.

ASSEMBLY

Make sure there are no shells in the chamber.

1. Remove all dirt and excess oil from gun, especially from the breech area, also barrel interior and ends.
2. Remove the forearm by pushing the forehead iron catch upwards, this allows the nose of the forearm to release. With your other hand and at the same time you are pushing the iron catch release upwards, separate the forearm from the barrel (Photo 1).

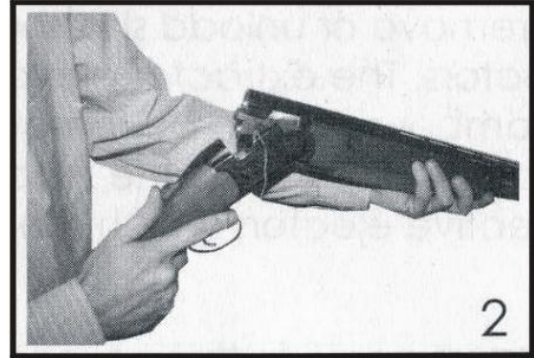
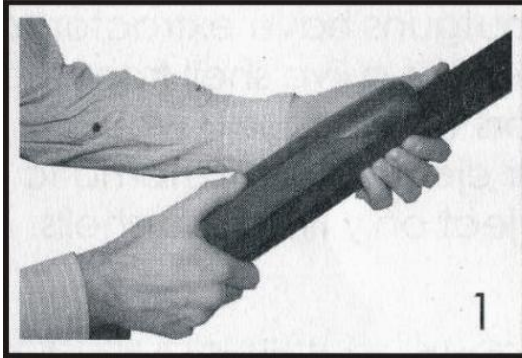

3. Lightly oil the already cleaned contact points. Attach barrels to action by grasping the grip of the stock with your right hand and placing the stock under your right arm. With your right thumb move the opening lever to the right. Now hold the barrels with your free hand and slide the barrels through the top of the receiver, with the barrel's nose pointing down until the hinge notch engages with the hinge pins (Photo 2).
 4. Keeping the hinge pin notch engaged with the hinge pin, lift the nose of the barrels until the action closes.
- Caution: If you attempt to close the gun and the barrels bind or don't seem to fit then the hinge pin and notch are not engaged. DO NOT FORCE, try again.** Release the hinge pin and notch and the barrels will be locked in place.
5. Replace the forearm on the gun by sliding the rear of the forearm into the barrel at the same angle by which you removed it. The round rear of the forearm should match the round front of the receiver. Lift the nose of the forearm until it engages with the barrels with an audible "click." If the forearm release latch protrudes after the "click," gently push it in place (Photo 3)



LOADING AND OPERATING YOUR SHOTGUN

1. Slide the safety, located on the tang of the receiver, toward the butt of the gun into the “safe” position (Photo 4).

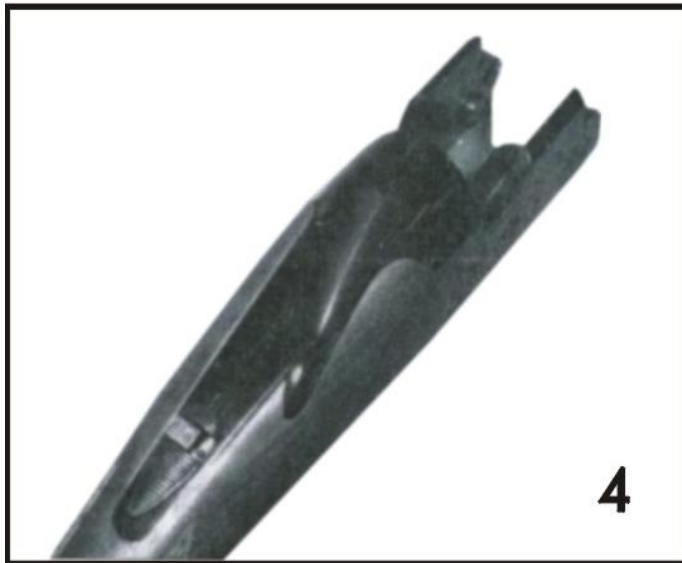

2. Break the action open.
 3. Check the barrels for any obstruction, including dirt and excess oil. **CAUTION:** Obstructions can increase barrel pressure sufficiently so that the barrel can explode when the gun is fired. This may result in serious injury or death to the shooter and others in the vicinity.
 4. Insert the shot shells into the chamber or chambers you plan to fire. **CAUTION:** Make sure the shells are of the proper gauge and chamber length for your gun.
- TriStar is not responsible for damage to a gun or shooter caused by malfunctioning ammunition, new, remanufactured, reloaded, or hand loaded.
5. Close the action.
 6. The order in which the barrels are fired depends upon the selective trigger.
 7. When contemplating firing your gun, be sure of your target, what is behind it, and the location of all persons with you or in your vicinity. Pick your target, release the safety by sliding it forward with your thumb and squeeze the trigger with your forefinger.
 8. To unload, press the opening lever to the right and open the action. Fired shells will be ejected and unfired shells will be elevated above the chamber on models with automatic selective ejectors. Models with extractors will only elevate both fired and unfired shells above the chamber.
- CAUTION:** In case of a misfire, wait at least 30 seconds while keeping the gun pointed in a safe direction. Then, carefully open the action away from yourself and others. If the primer on the rim is indented, the shell should be discarded in a manner that would prevent accidental injury to you and others. If there is no indentation on the primer or rim, your gun has malfunctioned and should be serviced by a qualified gunsmith. If the gun is under warranty it must be serviced by an authorized TriStar Gunsmith to not void warranty.

DISASSEMBLY

1. Make sure the gun is unloaded and no shells are in the chamber.
2. Close the action. Place the gun butt on your thigh and remove the forearm by pulling the forearm release latch or pressing the forearm release button. While pulling the nose of the forearm away from the barrels, slide the forearm forward until separated from the barrels.
3. Separate the barrels from the receiver by holding the stock of the gun in your right hand and the barrels in your left. Push the opening lever to the right with your thumb. Allow the nose of the barrels to drop and lift the barrels upward out of the receiver.
4. Close the top lever by pressing on the button located in the action (Photo 5).

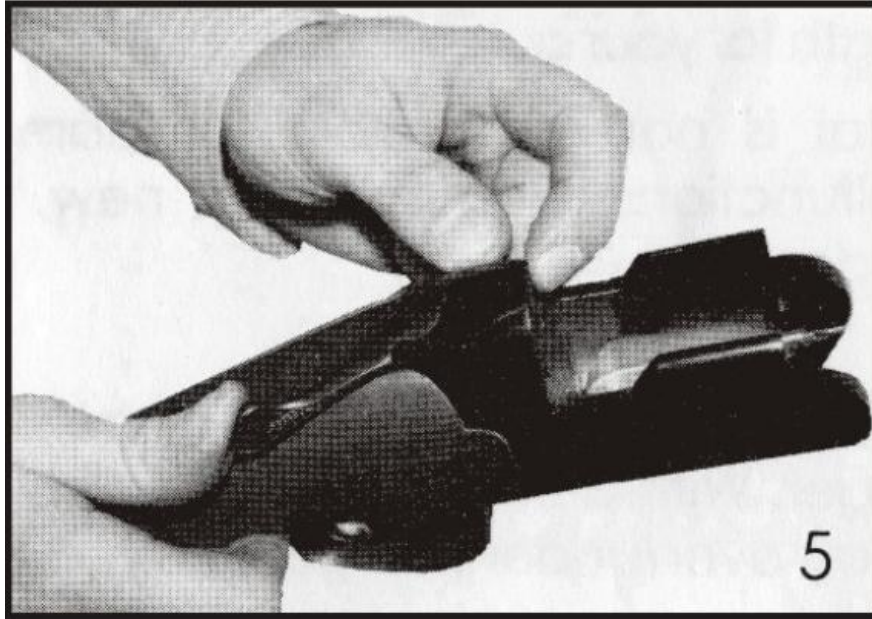

5. The gun can now be cleaned. The forearm should be reattached to the barrels for storage.
CAUTION: No further disassembly is needed, unless it is done by persons qualified in shotgun repair. Improper functioning and damage to the gun may result otherwise.

MAINTENANCE AND CLEANING

Caution: Make sure the gun in UNLOADED.

1. Make sure the broad, polished finely fitted mating surface of the breech block and receiver is especially clean and lightly oiled with high quality gun oil. Do not use silicone or lanolin (Do not use WD-40).
2. Run an oil patch through the bore with a cleaning rod starting from the breech end. To prevent leading, use a cleaning solvent and brass brush to clean the bore periodically. Follow this cleaning with one or two clean oil patches. Important: If your gun is equipped with choke tubes, do not use a brass brush to clean the barrels without having a choke tube installed. Barrels that utilize choke tubes must also have the choke tubes removed to clean and oil the threads inside the barrel and the choke tubes themselves. This will protect the threads and prevent dirt build up that can cause tubes to become difficult to remove.

Never fire your gun without choke tubes snugly tightened in barrels. Do not over tighten choke tubes. Wipe all exposed metal surfaces with an oiled cloth before storing. Do not squirt or pour oil into the inside mechanism because it may hamper proper functioning. After extended periods of heavy use, your gun should be taken to a qualified gunsmith to have the action disassembled for professional cleaning and lubrication.

3. Care for your wood stock and forearm the same way you would a piece of furniture with the same finish.

STORAGE

Clean thoroughly and oil your gun before storage. Store the gun in a case to prevent scratches and dents. Store your firearm in a dry place to prevent corrosion. **Store the gun away from children and in a place where it cannot be obtained by those unauthorized to use it. Always store gun unloaded and separately from any ammunition.**

USAGE OF CHOKE TUBES

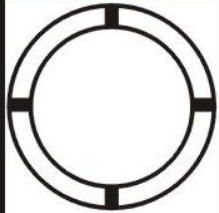
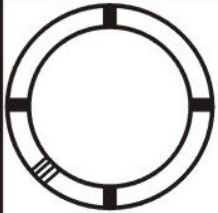
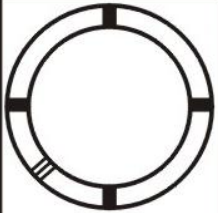
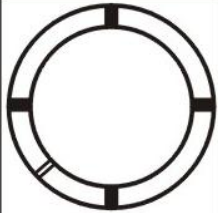
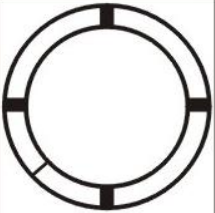
	SKEET	IC	M	IM	F
CHOKE TUBE					
BBLs	CL	★ ★ ★ ★	★ ★ ★	★ ★	★

The choke controls how open or tight the pattern of the shot will be. The chart below lists the chokes available (from open to tight), and the corresponding marks that indicate the specific choke.

Never fire your gun or run cleaning tools through a barrel that uses a choke tube without having a choke installed. The threads of the choke tube and the internal threads of the barrel should be cleaned after each use and before installation of the tube. Your TriStar shotgun uses Beretta®/Benelli® style choke tubes.

To install a tube, insert the tube into the top of the barrel and tighten with your fingers. Once the tube is finger tightened, tighten the rest of the way with the appropriate choke tube wrench until the tube is snug. **DO NOT** over tighten or forcefully tighten with the wrench.

IMPORTANT

USAGE OF STEEL SHOT

The shake (before constriction) in all modern shotguns has been established based on the pattern performance of shot shells loaded with lead shot. When using steel shot shells, you will notice a different performance in pattern density versus the established lead shot pattern, because the steel shot is harder and lighter than lead shot.

You should be aware of the following differences and cautions:

Never shoot steel shot loads in a full choked barrel or an improved modified choked barrel. To do may cause the barrel to swell or rupture. In general, steel shot fired with a modified choke will produce the equivalent of a lead full choke pattern. This will be true of all steel shot sized up to and including no. 2. The established improved cylinder chokes will produce the equivalent of a (lead) modified pattern.

All steel shot sized larger than no. 2, and including special sized such as F, T, etc., should be used only with improved cylinder chokes. These steel shot sizes, when used in an improved cylinder choke, will produce equivalent to (lead) full choke patterns. The established cylinder choke or bore will produce the equivalent of a modified (lead) pattern.

Additional information concerning the use of steel shot is available from the ammunition companies.

PARTS

To order parts, please be ready with the following information: Your name, address, telephone number, firearm serial number, make and model and payment information. Call TriStar Service Department (816) 421-1400.

HAZARDOUS MATERIAL WARNING

Discharging firearms in poorly ventilated areas, cleaning firearms, or handling ammunition, may result in exposure to lead and other substances known to cause birth defects, reproductive harm, and other serious physical injury. Have adequate ventilation at all times. Wash hands thoroughly after exposure.

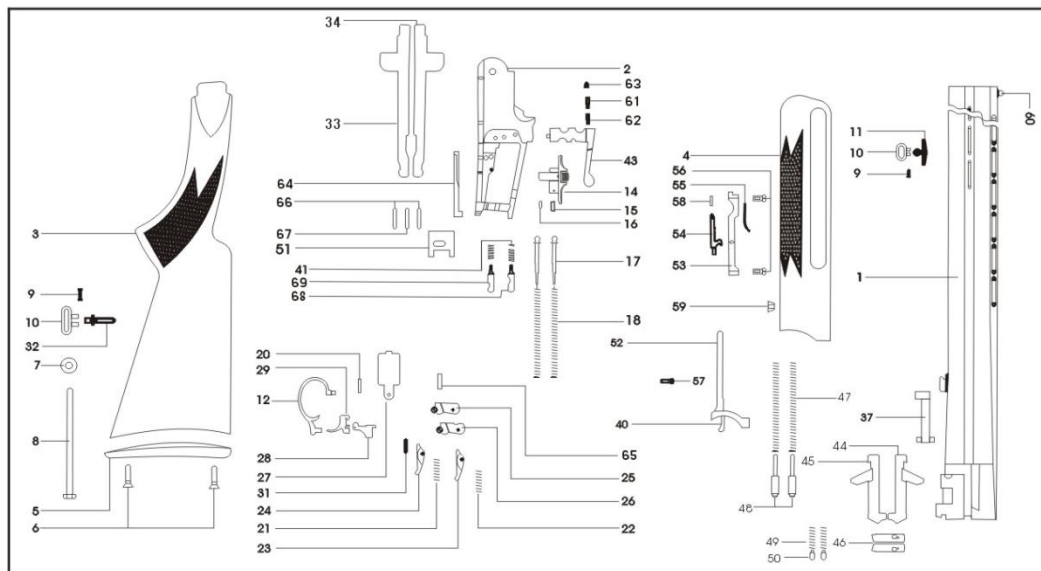

- | | |
|----------------------------|------------------------------------|
| 1- BARREL | 37- EXTRACTOR |
| 2- RECEIVER | 40- FOREARM COCKING ARM |
| 3- STOCK | 41- FIRING PIN SPRING |
| 4- FOREARM | 43- TOP LEVER |
| 5- BUTT PLATE / RECOIL PAD | 44- LEFT EJECTOR EXTRACTOR |
| 6- BUTT PLATE SCREW | 45- RIGHT EJECTOR EXTRACTOR |
| 7- STOCK BOLT WASHER | 46- LEFT AND RIGHT LEVER EXTRACTOR |
| 8- STOCK BOLT | 47- EJECTOR EXTRACTOR SPRINGS |
| 9- SWIVEL PIN | 48- EJECTOR EXTRACTOR PINS |
| 10- SWIVEL | 49- EJECTOR LEVER SPRING |
| 11- FRONT SWIVEL STUD | 50- EJECTOR EXTRACTOR LEVER PIN |
| 12- TRIGGER GUARD | 51- LOCKING BLOCK |
| 14- SAFETY SELECTOR | 52- FOREARM IRON |
| 15- SAFETY PIN | 53- TAKE DOWN LATCH BRACKET |
| 16- SAFETY SPRING PIN | 54- TAKE DOWN LATCH |
| 17- HAMMER SPRING PLUNGER | 55- TAKE DOWN LATCH SPRING |
| 18- HAMMER SPRING | 56- FOREARM SCREW |
| 20- TRIGGER PIN | 57- ESCUTCHEON SCREW |
| 21- SEAR-SAFETY SPRING | 58- TAKE DOWN LATCH PIN |
| 22- SEAR-SAFETY SPRING | 59- ESCUTCHEON MORTISE LOCH |
| 23- SEAR (RIGHT) | 60- FRONT BEAD |
| 24- SEAR (LEFT) | 61- TOP LEVER PLUNGER |
| 25- HAMMER (LEFT) | 62- TOP LEVER SPRING |
| 26- HAMMER (RIGHT) | 63- TOP LEVER PIN |
| 27- LOWER RECEIVER | 64- COCKING ARM |
| 28- SAFETY EXTRACTOR | 65- HAMMER PIN |
| 29- SINGLE TRIGGER | 66- LOWER RECEIVER PIN |
| 31- SEAR PIN | 67- FIRING PIN RETAINING PIN |
| 32- STOCK SWIVEL STUD | 68- FIRING PIN (TOP) |
| 33- LEFT EXTRACTOR | 69- FIRING PIN (BOTTOM) |
| 34- RIGHT EXTRACTOR | |

Ship the firearm prepaid to:

TriStar Sporting Arms
1816 Linn St.
North Kansas City, MO 64116

THANK YOU

Thank you for purchasing a TriStar shotgun. We are sure this gun will bring you years of hunting and/or shooting pleasure. Your satisfaction is the key to our success. Please let us know if we can be of service and relay any observations about your guns performance or appearance. For your questions or comments please visit www.tristarsportingarms.com

PURCHASER'S RECORD

Model Number _____

Purchase Date _____

Gauge or Caliber _____

Serial Number _____

Purchase Price _____

Store Name _____

SERVICE AGREEMENT AND LIMITED WARRANTY

TriStar agrees to service its products free of charge for defects in materials and workmanship in accordance with the service agreement listed below. The obligation of TriStar under this agreement is limited to the repair or replacement of unserviceable parts and does not cover any incidental or consequential damages. Other than the express warranty contained herein, TriStar makes no warranties, expressed or implied.

TriStar will repair or replace any unserviceable part(s) for (1) year from date of purchase and further will supply free parts (Wood not included) for an additional four (4) years in accordance with the above warranty statement provided your firearm had not been altered, abused, willfully damaged, or damaged by overpressure ammunition. This agreement is not transferable; its benefits apply only to the original purchaser.

To obtain free service during the time this agreement is in effect, make sure your firearm is unloaded and send to TriStar Sporting Arms.

This agreement and the warranties contained herein are void if your registration is not received within thirty (30) days from date of purchase.

Please visit www.tristarsportingarms.com to fill out and submit warranty.

SHIPPING

When returning your firearm for service, please take care in packing. Disassemble you gun wrap in a safe manner and place it in its original box. (THIS BOX WILL PROTECT THE GUN BUT IS NOT DESIGNED FOR SHIPPING). Wrap box in a cardboard box approved for interstate shipping. TriStar is not responsible for damage incurred during shipping.